

MOBILE

DURABLE

EASY TO USE

QUICK SET UP

MULTI  
FUNCTIONAL



One man, his dog and his **ALLIGATOR**

ALLIGATOR MOBILE SHEEP HANDLING - THE ONLY SHEEP HANDLING SYSTEM YOU'LL EVER NEED



**ALLIGATOR**  
MOBILE SHEEP HANDLING

## *Take the pens to the sheep, not the sheep to the pens*

Alligator has been helping British and international farmers for over four decades and has changed very little since it was originally launched. Alligator is the simplest, easiest and quickest mobile sheep handling system available on the market. Plus, with a number of small enhancements while gaining full Vehicle Certification Agency (VCA) approval, Alligator just got even better!



VCA certification refers to a set of regulatory, technical and safety requirements to ensure Alligator is fully road legal to satisfy European Union (EU) regulations.

Alligator underwent a series of stringent tests and now has additional safety and security features including; upgraded tyres, improved lighting and reflectors, secondary restraints for suspension arms, additional locating pins and a drawbar enhancement. Trailers also have Vehicle Identification Numbers (VIN) applied to the chassis as well as the drawbar to deter theft. As well as all these features, Stokbord is now the material used for trailer sides which is proven to be extremely weather resistant, strong, hygienic and lightweight.

Whatever the task, wherever the sheep are, Alligator is all you need to get the job done fast.

20 hurdle gathering pen, diamond forcing pen and shearing pen.

ALLIGATOR MOBILE SHEEP HANDLING - THE ONLY SHEEP HANDLING SYSTEM YOU'LL EVER NEED

MOBILE

DURABLE

EASY TO USE

QUICK SET UP

MULTI  
FUNCTIONAL

## Contents...

Alligator is Mobile...	4
Alligator is Durable...	6
Alligator is Easy to use...	8
Alligator is Quick to set up...	10
Alligator is Multi-functional...	12
The Alligator trailer	14
The drafting race	15
Handling configurations	16
Lightweight hurdles, pins, half posts, spreaders and connectors	18
Alligator gates	20
Shearing pen, yoke, side plates and footbath	22
Weighing	24
Footbathing	24
The Alligator range	26



*"Alligator is the simplest, easiest and quickest mobile sheep handling system to use on the market."*

John Urqhart,  
Foreshill, Lochluichart,  
Garve, Ross Shire



**ALLIGATOR**  
MOBILE SHEEP HANDLING

*Lightweight, modular system, engineered  
for strength and designed to be MOBILE.*



Take the pens to the sheep...

ALLIGATOR MOBILE SHEEP HANDLING - THE ONLY SHEEP HANDLING SYSTEM YOU'LL EVER NEED

MOBILE

DURABLE

EASY TO USE

QUICK SET UP

MULTI-FUNCTIONAL



Use an existing fence line if possible.

*“With Alligator, moving stock a short distance is avoided, we truly do take the pens to the sheep!”*

Mark Longlands  
Rushey Law Farm,  
Northumbria

## Alligator is **Mobile...**

Lightweight, modular system, engineered for strength, designed to be **MOBILE**.

Flexibility when and where you need it - you may operate between multiple locations or with busy roads making stock movement impractical and costly.

- ✓ **Weight where you need it with a well-balanced steel trailer quickly converting into a sturdy and fit for purpose pen and sorting race.**
- ✓ **All components transported on the trailer are lightweight but super strong aluminium.**
- ✓ **Easily transported as a single unit with a quad bike or vehicle between locations on public highways.**
- ✓ **Narrow country lanes or rough field terrain are no obstacle due to its superb suspension.**
- ✓ **Improve your bio-security reducing your stock movements significantly.**
- ✓ **Now with full VCA approval required by law for all trailers, Alligator is the safe and reliable choice.**



Detachable lighting board for safe highway travel.



One man, his dog and his Alligator.



Everything transported in the trailer.



**ALLIGATOR**  
MOBILE SHEEP HANDLING

*UK engineered, double weld aluminium  
with a bio-secure, non-slip mesh race floor.*



**ALLIGATOR**  
MOBILE SHEEP HANDLING



APPROVED PRODUCT

Diamond forcing pen with narrow spring lock gate.

ALLIGATOR MOBILE SHEEP HANDLING - THE ONLY SHEEP HANDLING SYSTEM YOU'LL EVER NEED

MOBILE

DURABLE

EASY TO USE

QUICK SET UP

MULTI-FUNCTIONAL

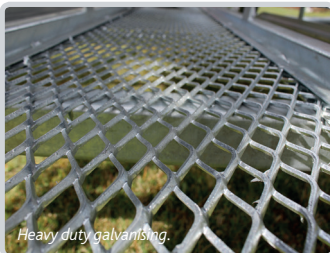

## Alligator is *Durable*...

UK engineered, double weld aluminium with a bio-secure, non-slip mesh race floor.

After four decades in the field Alligator systems are still going strong, testament to the build quality and design.

- ✓ Precision engineered from high grade raw materials.
- ✓ The heavy steel galvanised trailer provides weight and stability where you need it.
- ✓ All hurdles and additional components are aluminium which is super-strong yet lightweight for ease and longevity.
- ✓ Stokbord sides are weather resistant, strong, hygienic and lightweight.



*"This is my second Alligator, I had a system that was 20 years old and I bought a new one in 2006 and it is still doing the job."*

David Moore  
Orchard View, Norfolk



FOR MORE DETAILS OR A FREE DEMO PLEASE CALL 0845 600 8081 • VISIT US AT [WWW.COXANDRITCHEY.CO.UK](http://WWW.COXANDRITCHEY.CO.UK)



**ALLIGATOR**  
MOBILE SHEEP HANDLING

*Uniquely contoured hurdles for less drag.*

8

*"I found the simplicity of the Alligator an immediate strength, its' so easy to deploy and master in no time."*

Brian Knowles, High Borrow Bridge, Cumbria,  
Chairman of the Rough Fells Sheep Breeders Association (RFSBA)

*Even over long grass or uneven ground hurdles deploy easily.*



ALLIGATOR MOBILE SHEEP HANDLING - THE ONLY SHEEP HANDLING SYSTEM YOU'LL EVER NEED



MOBILE

DURABLE

EASY TO USE

QUICK SET UP

MULTI-FUNCTIONAL

## Alligator is *Easy to use...*

Super-strong and lightweight, with no heavy lifting during set-up and uniquely contoured hurdles.

One of the key strengths of Alligator to the user is in its simplicity and you quickly become an expert. There are no winches to master during deployment.

Hurdles are easy to deploy and connect together with a secure aluminium pin. Moreover, they move across uneven or grassy ground with little resistance as the lightweight hurdles have a uniquely contoured base to reduce drag.

- ✓ **A non-slip mesh floor self-cleans as mud drops through, animals can see the grass below, enter the race and run through better.**
- ✓ **Using guillotine gates allows one person to release and drive sheep through at the same time.**
- ✓ **All hurdles come supplied with a fixing pin and interlink with one another or other components in the Alligator range.**
- ✓ **2 way and 4 way connectors provide multiple pen configurations.**
- ✓ **Diamond forcing gates are spring loaded and come with their own supporting frame for added stability.**
- ✓ **Posts and spreaders provide solid, dependable support where you need it in the field.**
- ✓ **Everything fits on the trailer for simple and safe transportation.**



Long fixing pins with each hurdle.

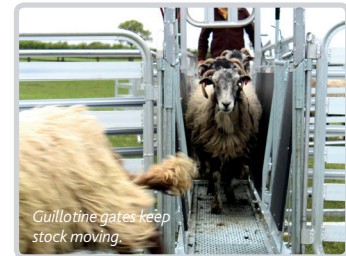

Guillotine gates keep stock moving.



Work up close if you need to.



*"We can be up and running in less than 10 minutes with no heavy lifting involved at all. Alligator really is as quick and easy as that."* Guy Moor, Nesbitt Farm, Wooler

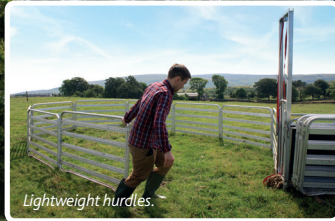

Lightweight hurdles.

10



Quick set up.



Half posts give extra support.



Wheel arms quickly removed.



ALLIGATOR MOBILE SHEEP HANDLING - THE ONLY SHEEP HANDLING SYSTEM YOU'LL EVER NEED

MOBILE

DURABLE

EASY TO USE

QUICK SET UP

MULTI-FUNCTIONAL

## Alligator is **Quick to set up...**

Reconfigured in minutes, however large a flock you are handling.

The trailer wheel arms are quickly removed from their axles. No winch mechanism is required as they are simply lowered enabling the trailer to sit on the ground. At just over 10 feet (3m), the trailer instantly becomes a race complete with a non-slip bio-secure mesh floor and three-way drafting.

- ✓ Before departing to your work location ensure the trailer is safely and evenly loaded; ensuring restraining straps, secondary restraints for suspension arms, all additional locating pins and all retaining straps are secured, with reflector and indicator lights fully functioning and in position.
- ✓ Drive to your desired location taking care that everything is safely carried on the trailer particularly over rough and difficult terrain.
- ✓ Upon arrival, choose a safe and as level a site as available - consider incorporating an existing fence line for additional support of your main holding pens.
- ✓ Remove the Alligator from your vehicle using the jockey wheel then lower this to the ground.
- ✓ Pull out the first extendable arm, unclip the carabiner pins and axle pins, lower the wheel arm and remove from axle. Repeat for the second wheel and move both to one side.
- ✓ Remove the front drawbar by removing the front pins and move to one side.
- ✓ Place the guillotine gates into position and the race is now ready.
- ✓ Deploy the hurdles to create your collecting pen, place half posts typically every 5 hurdles, add in your diamond gate/forcing pen, drenching race or footbath and gather your sheep.
- ✓ Upon completion of the task, pack away and run through the same safety check before departure.

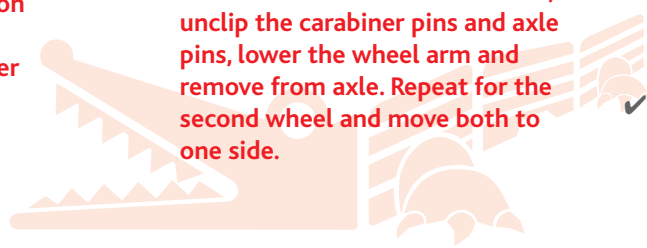



**ALLIGATOR**  
MOBILE SHEEP HANDLING

*Undertake all management tasks  
throughout the season.*

12

*Guillotine gates keep the job moving.*



ALLIGATOR MOBILE SHEEP HANDLING - THE ONLY SHEEP HANDLING SYSTEM YOU'LL EVER NEED

MOBILE

DURABLE

EASY TO USE

QUICK SET UP

MULTI-FUNCTIONAL



*"Alligator is so efficient, if you want to stop weighing it's quick to remove the equipment and then keep going using the race."*

David Moore  
Orchard View, Norfolk

## *Alligator is Multi-functional...*

Undertake all management tasks throughout the season; Alligator is never idle unlike fixed systems.

Use Alligator indoors in conjunction with other facilities, especially during bad weather. At lambing time additional pens are always useful and can be easily configured. Shearing is another task where Alligator can be incorporated either with your own equipment or when hiring a contractor.

- ✓ **3 way drafting, guillotine and diamond gates, yoke, double or single drenching race or footbath.**
- ✓ **With the inclusion of an optional middle gate, load bars and indicator, the race becomes a self-contained weigh platform.**
- ✓ **Wherever the work is, indoors or out, Alligator can help.**

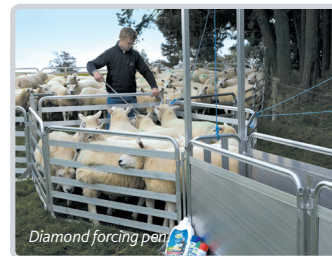

# The Alligator Trailer

Well balanced yet strong for quick and easy transportation on a public highway or over more challenging terrain, the trailer can be towed by a quad bike or vehicle.

Once at your place of work the trailer converts quickly into a drafting race - the very heart of the Alligator system.



*Extremely strong quick detach wheel arms.*



*Quick release suspension points and secondary safety fix for safe highway travel.*



*Removable lighting board.*



Go anywhere with Alligator.

ALLIGATOR MOBILE SHEEP HANDLING - THE ONLY SHEEP HANDLING SYSTEM YOU'LL EVER NEED

## The Drafting Race

At just over 10 feet (3058mm) the hot-dip galvanised steel race provides strength and weight where it is required.

Complete with bio-secure Stokbord sides and non-slip self-cleaning mesh floor, the race offers 3 way drafting and enables all manner of pen size and layout to suit the job in hand.



*Converts in minutes from trailer to race.*



*Non-slip self cleaning mesh floor.*



*Diamond forcing pen and drafting race.*

# Handling configurations

## Total flexibility

The 10ft race can be the preferred option for handling small numbers of sheep. However, when handling bigger numbers, two additional and larger race configurations can be selected; the 18" for working outside, or the 33" for working inside. It is recommended to incorporate sheeted hurdles for drenching/handling races like this.

16

Basic system with half posts deployed, a diamond forcing pen using sheeted hurdles and a middle gate.

ALLIGATOR MOBILE SHEEP HANDLING - THE ONLY SHEEP HANDLING SYSTEM YOU'LL EVER NEED



*Adding side pens allows 3 way drafting.*



**ALLIGATOR**  
MOBILE SHEEP HANDLING



*Using a wide race for vaccinating.*



*Adapt your existing pens to suit.*



## Lightweight hurdles, pins, half posts, spreaders and connectors

*Unique contoured hurdles for less drag.*



18

**LIGHTWEIGHT 5' HURDLES** are double welded high grade aluminium with a uniquely contoured base to reduce drag on uneven and grassy sites. 5' hurdles come as barred or sheeted and can be interchanged as required. Each has a long aluminium fixing pin ensuring a flexible yet secure interconnection between hurdles.

**HALF POSTS** provide additional support and are best utilised every 5 hurdles on a gathering pen and can also be staked down. Setting-up adjacent to a boundary fence or by using the towing vehicle can also provide additional temporary support.

**SPREADERS** provide extra stability in the field with 18" or 33" frame widths available and are especially useful for a long drenching race. An 18" Spreader is also available to suit a drop date.

**2 WAY AND 4 WAY CONNECTORS** can be incorporated when two female hurdle ends or four hurdles meet perhaps in multiple drafting or lambing pen formation. Also if other existing equipment is being used along with Alligator.

An **OPTIONAL WINCH** is available for larger systems or if a person wishes to deploy the wheel arms in a more gradual way. The winch simply fits over the suspension box and clips onto the wheel arm quickly and easily.

*Half-posts provide additional support.*



*Spreaders provide extra stability.*



*2 way and 4 way connectors can be incorporated.*



*Optional winch quickly fits over suspension column.*





5' HURDLE BARRED (1525MM X 900MM)

#850000



5' HURDLE SHEETED (1525MM X 900MM)

#850002



PINS

#850018



2-WAY CONNECTOR

#850022



4-WAY CONNECTOR

#850024

19

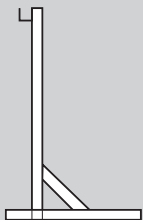

HALF POST 30" (750MM)

#850026

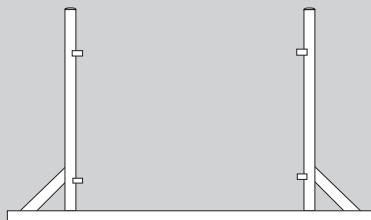

33" SPREADER FRAME ONLY (900MM)

#850030

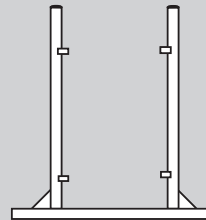

18" SPREADER (450MM)

#850028

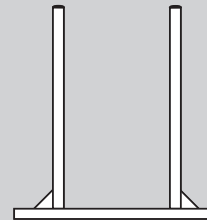

18" SPREADER TO SUIT DROP GATE

#850112

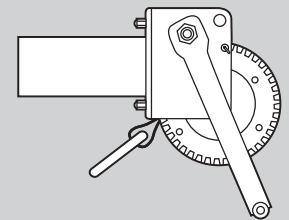

WINCH C/W BRACKET

#850058

# Alligator Gates



20



## Forcing pens

When incorporated with a 2 or 4 hurdle configuration (for a diamond), extremely effective forcing pens are created. **THE 5' FORCING/DIAMOND GATE** or **33" SPREADER GATE** offer wide or narrower options. Both come with built in frames for added stability, are spring loaded and stay open if required. They also have large quick and easy-close latches.

## 18" drop gates

18" drop gates come in barred or sheeted options and fit into the guillotine frame for the front and rear of the race. This can speed the flow-through of animals with the pull of a rope.



## Anti-backing gates

The Anti-backing gate keeps sheep moving in the correct direction, prevents bottlenecks and speeds up the flow of sheep forwards with less animal and handler stress.

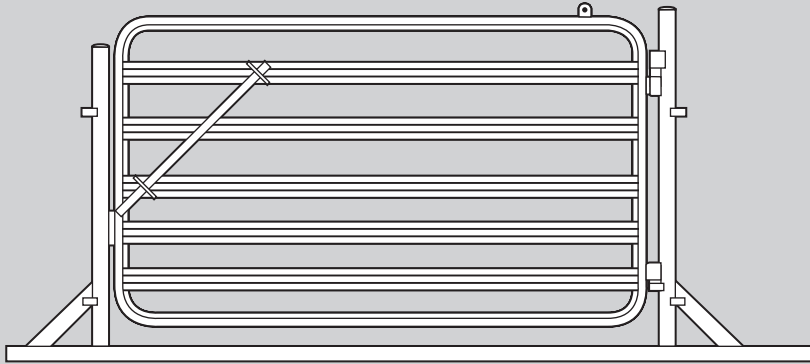

5' DIAMOND GATE C/W FRAME (2198MM X 1053MM)  
#850032

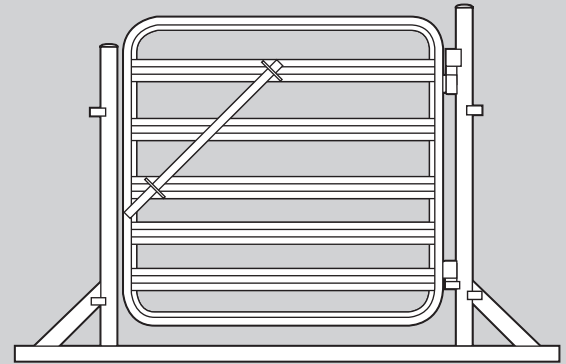

33" SPREADER C/W GATE (900MM)  
#850036

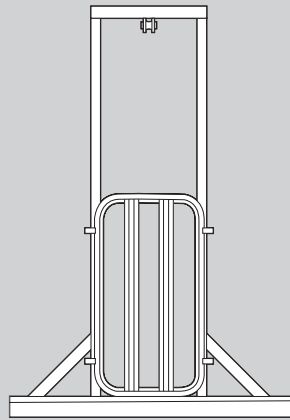

18" GUILLOTINE GATE  
(2000MM X 1200MM) #850034

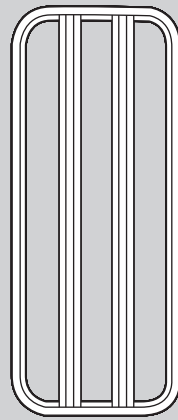

DROP GATE BARRED HIGH  
(40") #850046

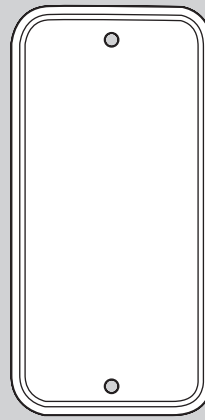

DROP GATE SHEETED HIGH  
(40") #850050

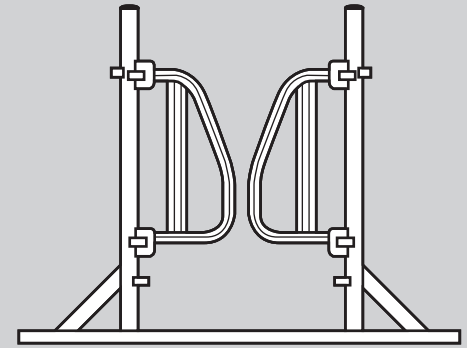

ANTI-BACKING GATE  
#850042



**ALLIGATOR**  
MOBILE SHEEP HANDLING

## *Shearing pen, yoke, side plates and footbath.*

22

A **FULLY PORTABLE SHEARING PEN** attaches onto the race, complete with spring loaded gate, shearing plant stand and a stay-clean plastic mesh floor. A contractors setup, affordable and available at your place instead!

The **YOKE** handles even horned sheep providing restraint with the minimum of stress to animal or handler and links to hurdles or small side plates allow it to be incorporated any way.

*The shearing pen complete with floor and plant stand fits onto the Alligator easily.*



*Hold even horned breeds in the yoke.*



*Side plates with yoke.*



*Footbath fits easily in the race.*

ALLIGATOR MOBILE SHEEP HANDLING - THE ONLY SHEEP HANDLING SYSTEM YOU'LL EVER NEED

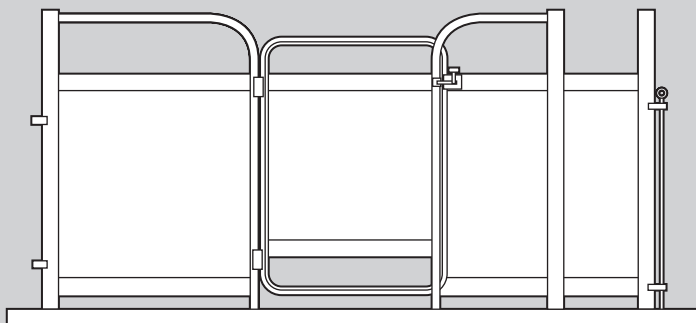

SHEARING PEN WALL C/W GATE AND SHEARING PLANT STAND  
**#850040**

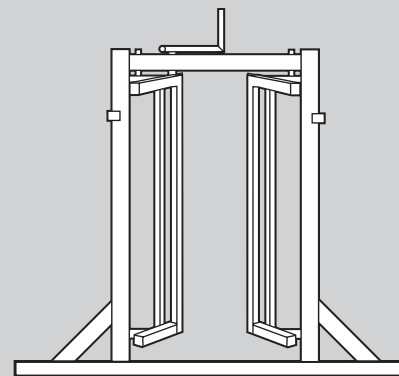
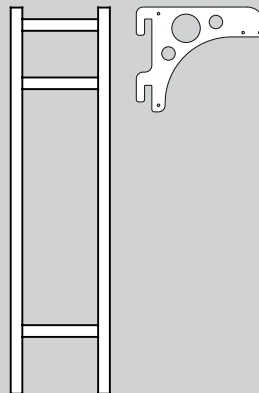

YOKE  
**#850038**

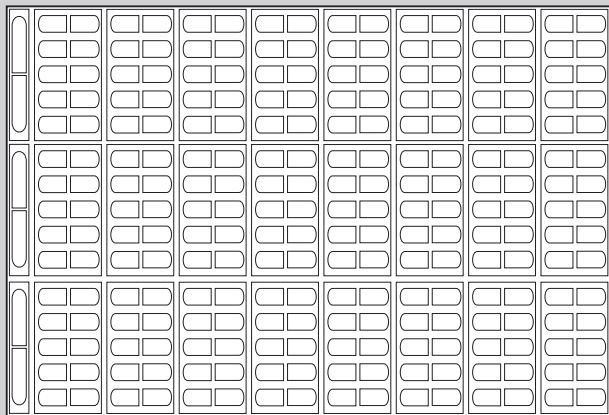

SHEARING PEN FLOOR (6'6" X 5'0")  
**#850132**



FOOTBATH NARROW (13" X 125")  
**#850060**

SIDE PLATES X 2  
 (IMAGE NOT SHOWN)  
**#850044**

SPARE WHEEL C/W  
 ROAD TYRE (EACH) **#850124**

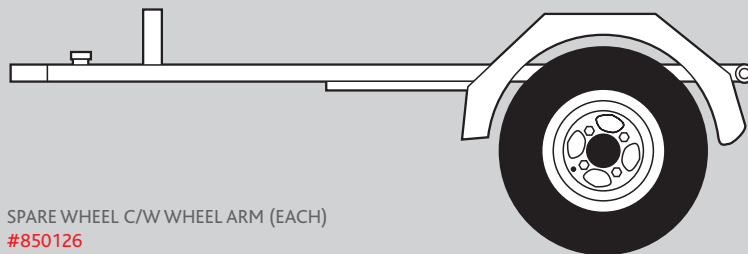
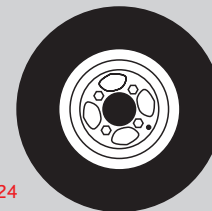

SPARE WHEEL C/W WHEEL ARM (EACH)  
**#850126**



**ALLIGATOR**  
MOBILE SHEEP HANDLING

*Weighing where and when you need it.*

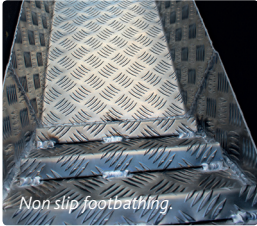

*Non slip footbathing.*

24

## ***Footbathing***

Footbathing is made easy by inserting the surprisingly lightweight corrosion resistant aluminium footbath into the race.

The embossed non-slip chequer plate is heavy gauge and three welded steps provide easy entry and exit encouraging stock movement.

*A simple and cost effective weighing solution.*

ALLIGATOR MOBILE SHEEP HANDLING - THE ONLY SHEEP HANDLING SYSTEM YOU'LL EVER NEED



# Weighing

Inclusion of a middle gate quickly converts the race into a very cost effective fully functioning weigh platform.

An aluminium platform with load bar fits snugly in the race connected to a digital readout on a 12 volt battery. Eid readers can be incorporated too with a cable free bluetooth solution. All of this fits into the trailer for ease of transportation.

A range of market leading EiD sheep tags and readers are also available - just ask about a complete solution!



Weighing platform and middle gate.



Weighing and 3 way drafting.

*"We never have to bring the sheep back to the farm, Alligator is a big help with timely jobs and stands up to anything we throw at it"*

**Ceri & Phil Rundle**

Bwlch Isaf, Bodfari, Denbigh, North Wales

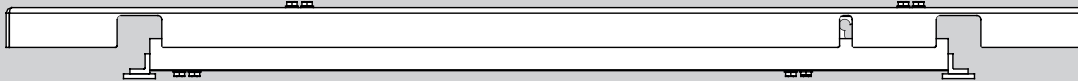

WEIGH TRAY (1360mm X 312mm)  
#850066

SCALE BASE ASSEMBLY 200KG  
#850166

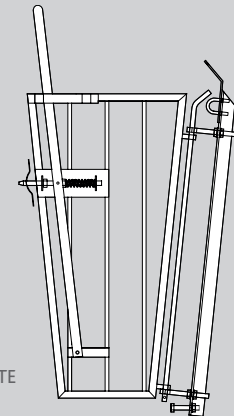

MIDDLE GATE  
#850146



*Basic system plus diamond forcing pen and middle gate.*

## *The Alligator range*

26

Our technical support team can advise on the Alligator package you require and a free on farm demonstration may help in your decision which we can arrange. A basic system may be your starting point with component additions - all held in stock and ready for immediate delivery via your local stockist throughout the UK. Finance packages and attractive trade-in deals are available.

The basic Alligator system is the most popular allowing up to 200 sheep to be handled at any one time. Many choose to add a diamond forcing pen to this, running smaller numbers from the large gathering pen into this and then from there into the race for treating or drafting as required. Additional components can be added as and when required such as dosing race, weighing systems, shearing pen and footbath etc. The options are flexible to suit.

ALLIGATOR MOBILE SHEEP HANDLING - THE ONLY SHEEP HANDLING SYSTEM YOU'LL EVER NEED

## Basic System

FOR HANDLING UP  
TO 200 SHEEP

#850200

- Trailer c/w 3 way drafting race
- 15 x 5' hurdles
- 3 x half posts
- 2 x drop/guillotine gates
- 1 x 4 way & 1 x 2 way connector
- 4 x spare pins
- 1 x lighting board

## Smallholder System

FOR HANDLING LESS THAN  
100 SHEEP

#850201

- Trailer c/w 3 way drafting race
- 10 x 5' hurdles
- 2 x half posts
- 2 x drop/guillotine gates
- 1 x 4 way & 1 x 2 way connector
- 4 x spare pins
- 1 x lighting board

## Large System

A LARGER SYSTEM FOR A FLOCK  
OF UP TO 600 TO 750 SHEEP

#850300

- Trailer c/w 3 way drafting race
- 35 x 5' hurdles
- 6 x 5' sheeted hurdles
- 7 x half posts
- 2 x drop/guillotine gates
- 2 x 33" spreader
- 1 x 5' wide forcing gate
- 1 x 33" spreader & narrow forcing gate
- 1 x 4 way & 1 x 2 way connector
- 6 x spare pins
- 1 x lighting board

**ADD A FORCING PEN BUNDLE TO  
YOUR SMALLHOLDER OR BASIC SYSTEM**

Ask about our special promotional rates!

**FORCING PEN #850264**

- 1 x 5' wide forcing gate
- 4 x 5' barred hurdles
- 1 x half post



Basic system with 15 x hurdles.



**ALLIGATOR**  
MOBILE SHEEP HANDLING

## THE ONLY SHEEP HANDLING SYSTEM YOU'LL EVER NEED

- ✓ For more information call **0845 600 8081**
- ✓ Email us at **hub@allflex.co.uk**
- ✓ Visit us at **www.coxandritchey.co.uk**
- ✓ See Alligator in action  
**www.youtube.com/coxagri**



## COX & RITCHEY

1 Greencroft Industrial Park  
Stanley  
County Durham  
DH9 7YA

Alligator is distributed through Cox & Ritchey,  
part of The Allflex UK Group Ltd